



Gummiflansche
Rubber flanges
Brides souples
Bridas de goma
Flangias di gomma

Catalogue
2003/2004



Gummiflansche / Rubber flanges

Mono-Jetronic

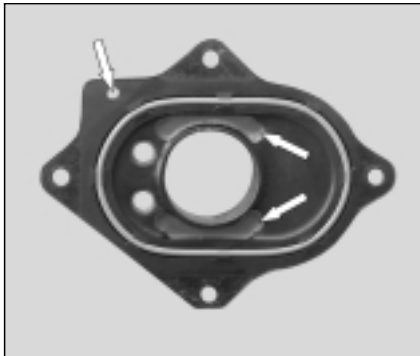

Fig. 1
3.50001.30.0



Fig. 2
3.50001.36.0



Fig. 3
3.50001.43.0



Fig. 4
3.50001.44.0

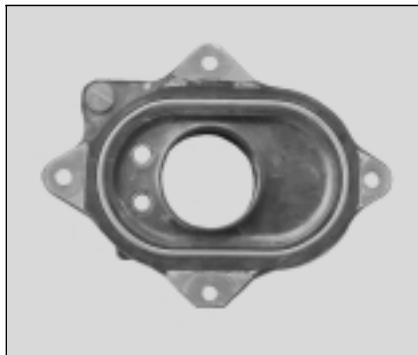

Fig. 5
3.50001.45.0

Vergaser / Carburettor

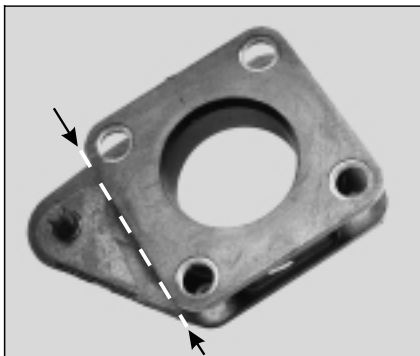

Fig. 6
3.50000.31.0
CDT/U

→ ← ggf. anpassen
adapt if necessary



Fig. 7
3.50000.34.0
1B3



Fig. 8
3.50000.35.0
34 PICT-5



Fig. 9
3.50001.25.0
2E2



Fig. 10
3.50001.26.0
2E3



Fig. 11
3.50001.27.0
2E3

Gummiflansche / Rubber flanges

Vergaser / Carburettor



Fig. 12
3.50001.28.0
2B2/3



Fig. 13
3.50001.29.0
2E3



Fig. 14
3.50001.31.0
2E-E



Fig. 15
3.50001.32.0
2E-E



Fig. 16
3.50001.33.0
2E-E



Fig. 17
3.50001.34.0
2B5



Fig. 18
3.50001.37.0
34 PICT-5



Fig. 19
3.50001.38.0
Keihin



Fig. 20
3.50001.39.0
Keihin



Fig. 21
3.50001.40.0
2B4









Fig. 22
3.50001.41.0
2B-E









Fig. 23
3.50001.42.0
Varajet II Opel







Mono-Jetronic

 				
<p>3.50001.30.0 Mono-Jetronic</p> <p>OE-Nr. * 050 129 761 A 050 129 761 B 050 129 761 F 050 129 761 H</p>	<p>Fig. 1</p> <p>AUDI 80 (89, 89Q, 8A, B3) S/quattro (66 kW) 1.8 80 (89, 89Q, 8A, B3) E (82 kW) 1.8 80 (8C, B4) (52 kW) 1.6 80 (8C, B4) (66 kW) 2.0 80 Avant (8C, B4) (66 kW) 2.0 100 (44, 44Q, C3) (66 kW) 1.8 100 Avant (44, 44Q, C3)/quattro KAT (65 kW) 1.8 100 Avant (44, 44Q, C3)/quattro KAT (66 kW) 1.8</p> <p>SEAT CORDOBA (6K2/C2) (55 kW) 1.6 CORDOBA (6K2/C2) (66 kW) 1.8 CORDOBA Vario (6K5) (55 kW) 1.6 IBIZA II (6K1) (55 kW) 1.6 IBIZA II (6K1) (66 kW) 1.8 INCA (6K9) (55 kW) 1.6 TOLEDO I (1L) (52 kW) 1.6 TOLEDO I (1L) (54 kW) 1.6 TOLEDO I (1L) (65 kW) 1.8 TOLEDO I (1L) (66 kW) 1.8</p> <p>VW GOLF II (19E) KAT (66 kW) 1.8 GOLF III (1H1) (55 kW) 1.8 GOLF III (1H1) (66 kW) 1.8 GOLF III (1H1) Syncro (1HX1) (66 kW) 1.8 GOLF III Variant (1H5) (55 kW) 1.8 GOLF III Variant (1H5) (66 kW) 1.8 GOLF III Cabriolet (1E7) (55 kW) 1.8 GOLF III Cabriolet (1E7) (66 kW) 1.8 JETTA II (19E) KAT (66 kW) 1.8 PASSAT (3A2, 35I) (53 kW) 1.6 PASSAT (3A2, 35I) (55 kW) 1.8 PASSAT (3A2, 35I) (66 kW) 1.8 PASSAT Variant (3A5, 35I) (53 kW) 1.6 PASSAT Variant (3A5, 35I) (55 kW) 1.8 PASSAT Variant (3A5, 35I) (66 kW) 1.8 POLO CLASSIC (6KV2) 75 (55 kW) 1.6 VENTO (1H2) (55 kW) 1.8 VENTO (1H2) (66 kW) 1.8</p>	<p>PM DZ ABM ABT ABT 4B SH 4B</p> <p>1F ABS/ADZ 1F 1F ABS/ADZ 1F 1F 1F RP ABS/ADZ</p> <p>GX/RP AAM ABS/ADZ ABS/ADZ AAM ABS/ADZ AAM ABS/ADZ GX/RP 1F AAM ABS/ADZ/RP 1F AAM ABS/ADZ/RP 1F/AEE/ALM AAM ABS/ADZ</p>	<p>09.1986 - 10.1991 06.1986 - 08.1991 09.1991 - 12.1994 09.1991 - 12.1994 07.1992 - 01.1996 08.1985 - 11.1990 02.1986 - 07.1990 08.1985 - 10.1990</p> <p>02.1993 - 06.1999 02.1993 - 06.1999 09.1996 - 06.1999 03.1993 - 08.1999 03.1993 - 08.1999 11.1995 - 05.1998 05.1991 - 12.1993 05.1991 - 03.1999 05.1991 - 12.1996 11.1993 - 12.1996</p> <p>08.1987 - 10.1991 11.1991 - 08.1997 11.1991 - 08.1997 01.1993 - 08.1997 07.1993 - 04.1999 07.1993 - 04.1999 07.1993 - 05.1998 07.1993 - 05.1998 08.1987 - 10.1991 02.1988 - 09.1991 08.1990 - 08.1996 02.1988 - 08.1996 04.1988 - 09.1991 08.1990 - 05.1997 02.1988 - 05.1997 11.1995 - 09.2001 11.1991 - 09.1998 11.1991 - 09.1998</p>	
<p>3.50001.36.0 Mono-Jetronic</p> <p>OE-Nr. * 030 129 765 G</p>	<p>Fig. 2</p> <p>SEAT CORDOBA (6K2/C2) (44 kW) 1.4 IBIZA II (6K1) (40 kW) 1.3 IBIZA II (6K1) (44 kW) 1.4 GOLF III (1H1) (40 kW) 1.4 GOLF III (1H1) (44 kW) 1.4 GOLF III Variant (1H5) (40 kW) 1.4 POLO (86C) KAT (40 kW) 1.3 POLO Coupe (86C) KAT (40 kW) 1.3 VENTO (1H2) (44 kW) 1.4</p>	<p>ABD/AEX/AKV/ANX/APQ AAV ABD/AEX/AKV/APQ ABD/AEX MH (KAT)/NZ/2G/AAV AAV ABD/AEX</p>	<p>06.1994 - 06.1999 03.1993 - 12.1996 09.1993 - 08.1999 11.1991 - 08.1997 10.1991 - 08.1997 07.1993 - 04.1999 01.1991 - 01.1992 07.1987 - 08.1994 11.1991 - 09.1998</p>	<p>Motor > 100 000</p>
<p>3.50001.43.0 Mono-Jetronic</p> <p>OE-Nr. * 032 129 765</p>	<p>Fig. 3</p> <p>SEAT CORDOBA (6K2/C2) (55 kW) 1.6 IBIZA II (6K1) (55 kW) 1.6</p> <p>VW GOLF III (1H1) (55 kW) 1.6 POLO (6N1) 75 (55 kW) 1.6 VENTO (1H2) (55 kW) 1.6</p>	<p>ABU ABU AEA/ABU AEA/AEE/AHS AEA</p>	<p>02.1993 - 06.1999 03.1993 - 08.1999</p> <p>09.1992 - 08.1997 10.1994 - 10.1999 09.1992 - 09.1998</p>	
<p>3.50001.44.0 Mono-Jetronic</p> <p>OE-Nr. * 030 129 765 D</p>	<p>Fig. 4</p> <p>SEAT IBIZA II (6K1) (33 kW) 1.0</p> <p>VW POLO/Coupe (86C) KAT (33 kW) 1.0</p>	<p>AAU AAK, AAU</p>	<p>03.1993 - 09.1996 08.1989 - 09.1994</p>	
<p>3.50001.45.0 Mono-Jetronic</p> <p>OE-Nr. * 048 129 761 048 129 761 A</p>	<p>Fig. 5</p> <p>AUDI A6 (4A, C4) 2.0 Avant (4A, C4) 2.0 100 (4A, C4) 2.0 100 (4A, C4) E 2.0 100 Avant (4A, C4) E 2.0 100 Avant (4A, C4) E 2.0</p>	<p>AAE AAE AAE AAD/ABK AAE AAD/ABK</p>	<p>06.1994 - 02.1997 06.1994 - 01.1997 12.1990 - 06.1994 12.1990 - 06.1994 09.1991 - 06.1994 09.1991 - 06.1994</p>	

Vergaser / Carbuirettor

 					
3.50000.31.0 CDT/U OE-Nr. * 102 071 13 68 A 102 071 13 68	Fig. 6 MB 200 Stufenheck (W123) (62/69 kW) 2.0 200 Stufenheck (W123) (74/80 kW) 2.0 230 Stufenheck (W123) (80 kW) 2.3 200 T (S123) (74/80 kW) 2.0 230 T/C (S/C123) (80 kW) 2.3 230 G (W460 / 460,2) (66 kW) 2.3 220 "/8" (W115 / 115.015) (63/70 kW) 2.0 220 "/8" (W115 / 115.010) (66 kW) 2.2 220 "/8" (W115) (77 kW) 2.2	M 115.938/M 115.939 M 102.920/M 102.939 M 115.954 M 102.920/M 102.939 M 115.954 M 115.973 M 115.923/M 115.926 M 115.924 M 115.920	02.1976 - 08.1980 06.1980 - 11.1985 02.1976 - 03.1981 11.1980 - 11.1985 05.1977 - 03.1980 03.1979 - 07.1993 01.1968 - 01.1977 01.1968 - 07.1973 01.1968 - 07.1973		
3.50000.34.0 1B3 OE-Nr. * 030 129 765 030 129 765 C	Fig. 7 VW GOLF II (19E) (37 kW) 1.0 POLO (86C) (33 kW) 1.0 POLO (86C) KAT (33 kW) 1.0 POLO CLASSIC (86C) (33 kW) 1.0 POLO Coupe (86C) (33 kW) 1.0 POLO Coupe (86C) KAT (33 kW) 1.0	HZ HZ ACM HZ HZ ACM	01.1986 - 10.1991 01.1986 - 01.1992 08.1989 - 09.1994 01.1986 - 01.1986 08.1986 - 01.1992 08.1989 - 09.1994	Fgst-Nr. 004 801 >	
3.50000.35.0 34 PICT-5 OE-Nr. * 025 129 761 025 129 761 A	Fig. 8 VW TRANSPORTER T3 Bus/Kasten (44 kW) 1.9 TRANSPORTER T3 Pritsche/Fahrgest. (44 kW) 1.9	DF DF	08.1982 - 07.1992 09.1982 - 07.1992		
3.50001.25.0 2E2 OE-Nr. * 026 129 761 A 026 129 761 E	Fig. 9 AUDI 80 (81,85,B2) (55 kW) 1.6 80 (81,85,B2) (66 kW) 1.6 COUPE (81,85) GT (66 kW) 1.8 100 (44,44Q,C3) (66 kW) 1.8 VW CADDY I (14) (55 kW) 1.6 GOLF I Cabriolet (155) (53 kW) 1.6 GOLF I Cabriolet (155) (55/66 kW) 1.6/1.8 GOLF/JETTA II (19E) (53 kW) 1.6 GOLF/JETTA II (19E) (55 kW) 1.6 GOLF/JETTA II (19E) (55 kW) 1.6 GOLF/JETTA II (19E) (62 kW) 1.8 GOLF/JETTA II (19E) (66 kW) 1.8 GOLF II (19E) Syncro (66 kW) 1.8 JETTA II (19E) (66 kW) 1.8 PASSAT/Variant (32B) (53 kW) 1.6 PASSAT (32B) (55 kW) 1.6 PASSAT/Variant (32B) (64 kW) 1.8 PASSAT/Variant (32B) (66 kW) 1.8 PASSAT Stufenheck (32B) (53 kW) 1.6 PASSAT Stufenheck (32B) (55 kW) 1.6 PASSAT Stufenheck (32B) (64 kW) 1.8 PASSAT Stufenheck (32B) (66 kW) 1.8 PASSAT Variant (32B) Syncro (66 kW) 1.8 SANTANA (32B) (55 kW) 1.6 SANTANA (32B) (66 kW) 1.8 SCIROCCO (53B) (55 kW) 1.6 SCIROCCO (53B) (53 kW) 1.6 SCIROCCO (53B) (66 kW) 1.8	DT DS DS DS EM/EM/EW RE EW/EX RF (KAT) HM EZ RH HV GU GU RL RL DT RM DS RL DT RM DS DS DT DS DS RE EX	CH CH CH CH	08.1978 - 07.1986 01.1993 - 08.1986 09.1982 - 10.1988 08.1983 - 07.1989 01.1983 - 07.1992 04.1986 - 02.1990 08.1983 - 04.1992 02.1986 - 10.1991 08.1983 - 08.1991 08.1983 - 08.1991 08.1986 - 01.1990 08.1984 - 10.1991 02.1986 - 07.1991 08.1984 - 10.1991 02.1986 - 03.1988 08.1980 - 03.1988 05.1986 - 03.1988 01.1983 - 03.1988 01.1985 - 03.1988 01.1985 - 03.1988 05.1986 - 03.1988 01.1985 - 03.1988 01.1986 - 03.1988 08.1981 - 12.1984 01.1983 - 12.1984 01.1983 - 12.1989 04.1986 - 07.1990 08.1983 - 07.1992	
3.50001.26.0 2E3 OE-Nr. * 052 129 765 C	Fig. 10 VW DERBY (86C) (55 kW) 1.3 POLO/Coupe (86C) (55 kW) 1.3	GK GK	09.1982 - 12.1984 09.1982 - 09.1989		
3.50001.27.0 2E3 OE-Nr. * 052 129 765 E	Fig. 11 VW DERBY (86C) (40 kW) 1.3 GOLF/JETTA II (19E) (40 kW) 1.3 GOLF/JETTA II (19E) KAT (40 kW) 1.3 POLO (86C) (40 kW) 1.3 POLO (86C) KAT (40 kW) 1.3 POLO CLASSIC (86C) (40 kW) 1.3 POLO Coupe (86C) (40 kW) 1.3 POLO Coupe (86C) KAT (40 kW) 1.3	HK HK/MH MH (KAT)/NZ/2G HK/MH MH (KAT)/NZ/2G/AAV HK/MH HK/MH 2G/MH(KAT)/NZ	08.1983 12.1984 08.1983 06.1987 06.1986 12.1992 08.1983 07.1988 07.1987 09.1994 01.1985 07.1987 08.1983 06.1987 07.1987 08.1994		
3.50001.28.0 2B2/3 OE-Nr. * 055 129 761 B	Fig. 12 AUDI 80 (80, 82, B1) (63 kW) 1.6 100 (43, C2) (63 kW) 1.6 100 (43, C2) (63 kW) 2.0 100 Avant (43, C2) (63 kW) 1.6 100 Avant (43, C2) (63 kW) 2.0 VW PASSAT (32)/Variant (33) (63 kW) 1.6 SCIROCCO (53) (63 kW) 1.6	YP YV WA YV WA YP FR	01.1976 - 07.1978 08.1976 - 12.1978 06.1976 - 08.1978 07.1977 - 12.1978 08.1977 - 12.1978 01.1976 - 12.1978 08.1975 - 12.1978	Fgst-Nr. 826 2000 001 > Motor > 119 263 Motor > 119 263 Motor > 119 263 Motor > 119 263 Fgst-Nr. > 328 2300 000 Motor > 028 657	

Vergaser / Carbuirettor

						
3.50001.40.0 2B4 OE-Nr. * 1 270 693 1 273 911 13 11 1 270 693 13 11 1 273 911	Fig. 21	BMW 3 (E21) 316 (66 kW) 3 (E30) 316 (66 kW) 5 (E12) 518 (66 kW) 5 (E28) 518 (66 kW)	1.8 1.8 1.8 1.8	M 10 B 18 M 10 B 18 M 10 B 18 M 10 B 18	09.1980 - 08.1982 09.1983 - 09.1983 09.1980 - 05.1981 06.1981 - 09.1983	o.KAT o.KAT
3.50001.41.0 2B-E OE-Nr. * 1 278 994 1 287 346 13 11 1 278 994 13 11 1 287 346	Fig. 22	BMW 3 (E30) 316 (Ecotronic) (66 kW)	1.8	M 10 B 18	09.1983 - 12.1990	o.KAT
3.50001.42.0 Varajet II Opel OE-Nr. * 850 909 90 122 540	Fig. 23	OPEL ASCONA C/ASCONA C CC 1.6 S (66 kW) KADETT D/KADETT D Caravan 1.6 S (66 kW) KADETT E CC 1.6 S (66 kW) KADETT E/KADETT E Caravan 1.6 S (66 kW)	1.6 1.6 1.6 1.6	16 SH 16 SH 16 SH 16 SH	09.1981 - 08.1986 09.1981 - 08.1984 09.1984 - 08.1986 09.1984 - 08.1986	

O.E.-Nr. / No. ==> Pierburg-Nr. / No.

OE-Nr. *	Pierburg-Nr.	OE-Nr. *	Pierburg-Nr.	OE-Nr. *	Pierburg-Nr.
BMW		AUDI/VW		AUDI/VW	
1 270 693	3.50001.40.0	025 129 761	3.50000.35.0	050 129 761 E	3.50001.39.0
1 273 911	3.50001.40.0	025 129 761 A	3.50000.35.0	050 129 761 F	3.50001.30.0
1 278 994	3.50001.41.0	026 129 761 A	3.50001.25.0	050 129 761 H	3.50001.30.0
1 287 346	3.50001.41.0	026 129 761 E	3.50001.25.0	051 129 761	3.50001.33.0
13 11 1 270 693	3.50001.40.0	027 129 761	3.50001.39.0	052 129 765 C	3.50001.26.0
13 11 1 273 911	3.50001.40.0	027 129 761 A	3.50001.39.0	052 129 765 E	3.50001.27.0
13 11 1 278 994	3.50001.41.0	030 129 765	3.50000.34.0	055 129 761 B	3.50001.28.0
13 11 1 287 346	3.50001.41.0	030 129 765 C	3.50000.34.0	055 129 761 C	3.50001.37.0
		030 129 765 D	3.50001.44.0	055 129 761 D	3.50001.37.0
		030 129 765 G	3.50001.36.0		
DAIMLER CHRYSLER (MB)		032 129 765	3.50001.43.0		
102 071 13 68	3.50000.31.0	037 129 761	3.50001.29.0		
102 071 15 68	3.50001.31.0	048 129 761	3.50001.45.0		
A 102 071 13 68	3.50000.31.0	048 129 761 A	3.50001.45.0		
A 102 071 15 68	3.50001.31.0	049 129 761	3.50001.34.0		
OPEL		049 129 761 C	3.50001.38.0		
850 909	3.50001.42.0	050 129 761 A	3.50001.30.0		
90 122 540	3.50001.42.0	050 129 761 B	3.50001.30.0		
90 284 095	3.50001.32.0	050 129 761 C	3.50001.33.0		

Erläuterungen / Remarks / Remarques / Observaciones / Osservazioni

Code	D	GB	F	E	I
Fgst-Nr. xxx> Fgst-Nr. > xxx Motor xxx> Motor > xxx MT o.KAT G-KAT CH S	ab Fahrgestellnummer bis Fahrgestellnummer ab Motornummer bis Motornummer Handschtaltung ohne KAT geregelter KAT Schweiz Schweden	from chassis no. to chassis no. from moteur no. to moteur no. Manual transmission without catalytic three-way catalytic converter Switzerland Sweden	à partir no. chassis jusqu'à no. chassis à partir no. Moteur jusqu'à no. Moteur Transmission manuelle sans catalyseur catalyseur réglé Suisse Suède	de no. Chasis hasta no. Chasis de motor no. hasta motor no. Transmisión manual sin catalizador catalizador regulado Suiza Suecia	da tela no. a tela no. da motor no. a motor no. Transmissione manuale senza catalizzatore catalizzatore regolato Svizzera Svezia
OE-Nr. *	Die aufgeführten Referenznummern (O.E.-Nr.) dienen nur zu Vergleichszwecken und dürfen auf Rechnungen an den Endverbraucher nicht verwendet werden.	The O.E.-references listed are for comparison only and may not be used on invoices for customers.	Les références constructeur (O.E.-no.) ne servent que pour les comparaisons et ne doivent pas figurer sur les factures destinées aux consommateurs.	Las referencias (O.E.-no.) mencionadas sirven unicamente a fines de comparación. No deben figurar en las facturas destinadas al consumidor final.	Le referenze (O.E.-no.) menzionate servono unicamente a scopi di comparazione. Non devono figurare nelle fatture destinate al consumatore finale.
	Anwendung: Genaue Zuordnung und Ersatz, siehe TecDoc-CD bzw. auf TecDoc-Daten basierende Systeme. Änderungen vorbehalten.	Application: For exact application see TecDoc-CD or TecDoc data-based systems. Subject to change.	Applications: Pour les applications actuelles, voir TecDoc-CD ou systèmes basés sur les données TecDoc. Sous réserve de modifications.	Aplicaciones: Para las aplicaciones exáctas, véase el CD TecDoc o bien los sistemas basados en los datos TecDoc. Salvo modificaciones.	Applicazione: Per applicazione precisa consultare il CD TecDoc o i sistemi basati sui dati TecDoc. Salvo modifiche.

MOTOR SERVICE INTERNATIONAL



MSI Motor Service
International GmbH

Alfred-Pierburg-Straße 1
D-41460 Neuss
Phone +49 21 31-5 20-0
Fax +49 21 31-5 20-6 63

Untere Neckarstraße
D-74172 Neckarsulm
Phone +49 71 32-33 33 33
Fax +49 71 32-33 28 64

info@msi-motor-service.com
www.msi-motor-service.com

Pierburg Komponenten, Module und Systeme

- Kraftstoffversorgung
- Unterdruckversorgung
- Luftversorgung
- Schadstoffreduzierung
- Steuerung und Regelung

Pierburg components, modules and systems

- Fuel supply
- Vacuum generation
- Air supply
- Emission control
- Control and regulation

Composants, modules et systèmes Pierburg

- Alimentation en carburant
- Génération de dépression
- Alimentation en air
- Réduction des émissions nocives
- Commande et régulation

Componentes, módulos y sistemas de Pierburg

- Alimentación de combustible
- Alimentación de vacío
- Alimentación de aire
- Reducción de sustancias nocivas
- Mando y reglaje

Componenti, moduli e sistemi di Pierburg

- Alimentazione di combustibile
- Alimentazione di vuoto
- Alimentazione di aria
- Riduzione delle sostanze nocive
- Comando e regolazione

Pierburg-Vertretung · Distributor · Distributeur · Distribuidor · Distributore

© MSI Motor Service International GmbH
Printed in Germany
Reg.-Nr. 2/10 00-410.1
Edition: 06/2003
Order.-No. 8.40002.61.0

